

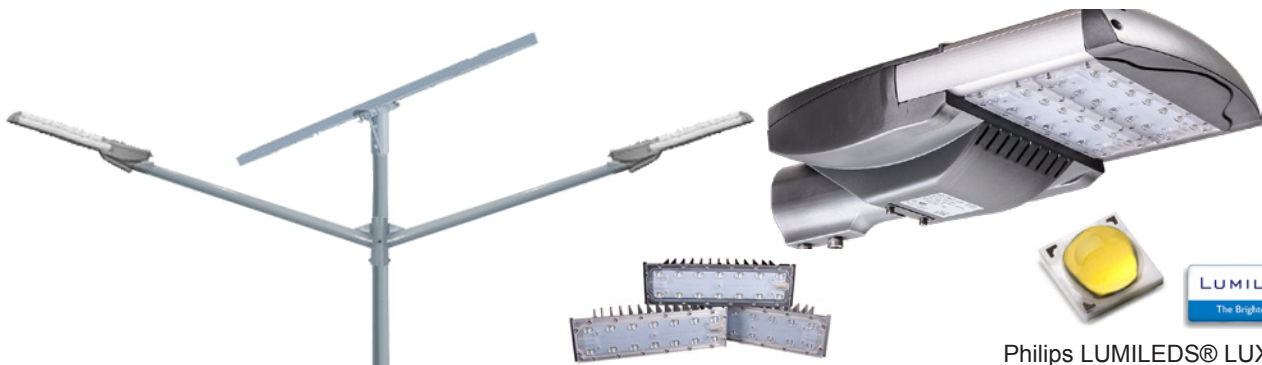

SL24

SOLAR DOUBLE LED STREET / PARKING LOT / AREA LIGHT
10W To 25W Double LED Lamps - Complete System With Pole



Modular design allows for longer life and greater efficiency.

Philips LUMILEDS® LUXEON T
Up to 185 lm/W efficiency.



- Sold as a complete, dual lamp lighting system with choice of pole.
- This system can be designed, engineered, and pre-programmed to automatically operate from dusk to dawn all year round. Or it can be programmed to operate for a single or dual timed modes instead. Dimming and motion detection are optionally available.
- Adjustable LED power between 10W to 25W per lamp. Typical options being 10W, 15W, 20W or 25W, with Type II, III, or V distribution. Light output from 1,850 to 4,625 lumens, per lamp. Choice of warm white (3,000k) or daylight white (5,500k). Other CCT options by special order.
- The solar panel size (wattage) and battery size (capacity) is based on the total LED power, geographic location of the site, and the hours or times of nightly operation.
- Pole height options include 15' (4.5m) or 20' (6m). Custom pole heights by special order.



Lowest Price*
Guarantee



Worldwide*
Shipping



10 Year*
System Warranty



20 Year*
Panel Warranty



Lifetime*
Tech Support



9120 Centerlinks Commerce Drive • Unit 3 • Fort Myers • Florida • 33912 • USA • Telephone: 239-461-5522

MONDAY - FRIDAY 8:00AM - 8:00PM (US EASTERN TIME)

www.solarilluminations.com • sales@solarilluminations.com



SL24

SOLAR DOUBLE LED STREET / PARKING LOT / AREA LIGHT
10W To 25W Double LED Lamps - Complete System With Pole

Solar Makes Sense

Using a solar lighting system is often **cheaper than trenching** cables to remote sites or through parking lots, under roads and sidewalks.



No monthly bills for electric usage, meter fees, or taxes.

Federal and local incentives may be available to offset the cost of the system. View our website for current incentives.



Renewable energy. Use the sun's unlimited power as a clean source of renewable energy.

Green Image. Let people know your company or organization is doing its part in reducing its reliance on unclean energy.



Purchase with Confidence



Established in 2002 with offices and warehouse located in Fort Myers, Florida where we store, assemble, ship, and support our products.



We stand behind our systems with a 20 year limited warranty on the solar panels, and a 10 year limited warranty on the system.



Our superior customer service and support is proven with our A+ rating with the Better Business Bureau.



Technical support is available for life! We'll be here to assist you with support and troubleshooting if the need arises.

Lowest Price* Guarantee

Worldwide* Shipping

10 Year* System Warranty

20 Year* Panel Warranty

Lifetime* Tech Support

9120 Centerlinks Commerce Drive • Unit 3 • Fort Myers • Florida • 33912 • USA • Telephone: 239-461-5522

MONDAY - FRIDAY 8:00AM - 8:00PM (US EASTERN TIME)

www.solarilluminations.com • sales@solarilluminations.com

*SUBJECT TO OUR TERMS & CONDITIONS, AND RETURNS POLICY



SL24

SOLAR DOUBLE LED STREET / PARKING LOT / AREA LIGHT
 10W To 25W Double LED Lamps - Complete System With Pole



PHILIPS
LUMILEDS



LUXEON™
never before possible

**DARK SKY
COMPLIANT LIGHTING**
Full Cutoff Light Fixture



Philips LUMILEDS LUXEON T LED emitters produce up to 185 lumens per Watt efficiency and have a life span greater than 100,000 hours of operation.



10-25 Watt LED Lamp - LUMILEDS® LUXEON T
 Provides approx. 1,850 to 4,625 lumens of light output per lamp.
 Total light output up to 9,250 lumens in back to back configuration.

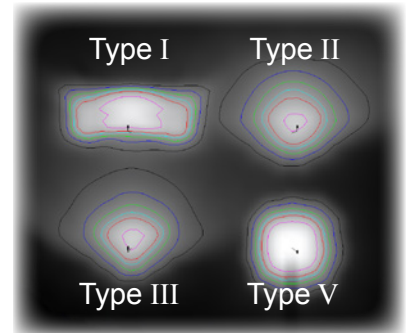

Each lamp is supplied in one of four different lighting distributions: (Type I, II, III, or V).

The standard power ranges above can be adjusted using the integrated dimming feature of our MPPT Control Module. For example, we can take our standard 25W Lamp and dim it down to 10W for a few hours each night or permanently depending on your requirements. We have full control over the power of our fixtures and the programmability of our system allowing us to design and specify our systems for any application around the world.

- Configured with one or multiple LED modules containing 14 Philips LUMILEDS® LUXEON T LEDs each.
- LED color temperature is daylight white (5,500K) or warm white (3,000K). Other CCT options by special order.
- LED life expectancy is typically up to 100,000 hours or equal to about 22 years.
- LEDs are powered by internal drivers, with integrated PWM Dimming control and multi-driver redundancy.



Easy Access to Driver and Connections



Vented Design for Ideal Heat Dissipation



Supplied with Stainless Steel Hardware



Adjustable Arm from 0°, 10°, or 15° for Increased Projection

Lowest Price*
Guarantee



Worldwide*
Shipping



10 Year*
System Warranty



20 Year*
Panel Warranty



Lifetime*
Tech Support



9120 Centerlinks Commerce Drive • Unit 3 • Fort Myers • Florida • 33912 • USA • Telephone: 239-461-5522

MONDAY - FRIDAY 8:00AM - 8:00PM (US EASTERN TIME)

www.solarilluminations.com • sales@solarilluminations.com

*SUBJECT TO OUR TERMS & CONDITIONS, AND RETURNS POLICY



SL24

SOLAR DOUBLE LED STREET / PARKING LOT / AREA LIGHT
 10W To 25W Double LED Lamps - Complete System With Pole



Solar Panel

Systems are supplied with high quality monocrystalline or polycrystalline solar panels with the highest performance and efficiency. They are designed to endure the harshest environments, and are guaranteed to provide power for well over 20 years. Typically manufactured in the USA, Canada, or Germany. The solar panel power is subject to LED consumption, installation location, and illumination period. Please consult with our engineers for specific solar power recommendations.

MC4 Connector



Photovoltaic Module

- Highly efficient monocrystalline or polycrystalline solar panel with aluminum frame, anti-aging, and encapsulated membrane.
- Anti-reflective and anti-soiling surface that reduces power losses from dirt and dust.
- Certified to withstand high wind loads (340PSI) and snow loads (780PSI); and resistance to high salt and ammonia.
- Manufactured to international standards, verified and certified by independent testing laboratories. (UL, ETL, IEC, MCS, & TUV)
- Assembled to strict quality control standards; international standards ISO 9001 and ISO 14001.
- Range of solar panel power available from 45W to +500W.
- The solar panel power is subject to LED consumption, installation location, and illumination period. Please consult our engineers for specific solar power requirements.
- Solar panels can be supplied in a single or dual format (2 x 70W = 140W, 2 x 100W = 200W etc.)
- Typical solar panel life is over 30 years, subject to environmental factors.

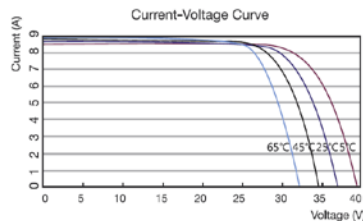
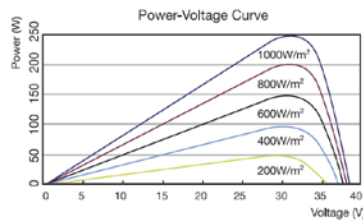
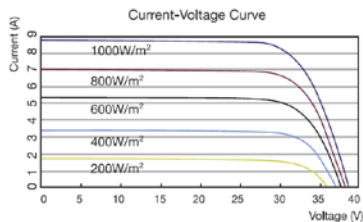

*SUBJECT TO OUR TERMS & CONDITIONS, AND RETURNS POLICY

Lowest Price*
Guarantee

Worldwide*
Shipping

10 Year*
System Warranty

20 Year*
Panel Warranty

Lifetime*
Tech Support

9120 Centerlinks Commerce Drive • Unit 3 • Fort Myers • Florida • 33912 • USA • Telephone: 239-461-5522

MONDAY - FRIDAY 8:00AM - 8:00PM (US EASTERN TIME)

www.solarilluminations.com • sales@solarilluminations.com



SL24

SOLAR DOUBLE LED STREET / PARKING LOT / AREA LIGHT
 10W To 25W Double LED Lamps - Complete System With Pole



Made in the USA



QUALITY SYSTEM CERTIFIED
ISO 9001
ISO/TS 16949
 ENVIRONMENTAL SYSTEM CERTIFIED
ISO 14001



“EastPenn batteries are engineered and tested to provide reliable, long-lasting power for Photovoltaic (PV) and renewable energy applications where frequent deep cycles are required and minimum maintenance is desirable.”



Battery

- Manufactured by: East Penn Manufacturing Co. Inc.
- 100 % made in the USA.
- Supplied standard with two 12 Volt AGM VRLA deep cycle batteries.
- GEL batteries are available as an option.
- Battery capacity ranges from 32 AH up to 245 AH (at 20 HR Rate) subject to model selected and customer operation requirements.
- Typical maximum daily DOD designed around 30%.
- Non-spillable (defined by DOT, ICAO and IATA), valve regulated, NonHAZMAT.
- Conforms to ISO9001, ISO/TS 16949, and ISO14001 standards.
- Typical battery life is approximately 5 to 7 years, subject to environmental factors.

VRLA technology

VRLA stands for Valve Regulated Lead Acid, which means the batteries are sealed. Gas will escape through the safety valves only in case of overcharging or cell failure. VRLA batteries are maintenance free for life.

Sealed (VRLA) AGM batteries

AGM stands for Absorbent Glass Mat. In these batteries the electrolyte is absorbed into a glass-fiber mat between the plates using capillary action.

Sealed (VRLA) Gel batteries

Electrolyte immobilized as gel, Gel batteries in general have a longer service life and better cycle capacity than AGM batteries.

Our AGM and Gel batteries have exceptional discharge recovery, even after deep or prolonged discharge. However, it should be noted that repetitive deep discharge and prolonged deep discharge have a negative influence on the service life of all lead acid batteries.

The rated capacity of our AGM and Gel Deep Cycle batteries refers to 20 hour discharge. (i.e. a discharge current of 0.05 C).

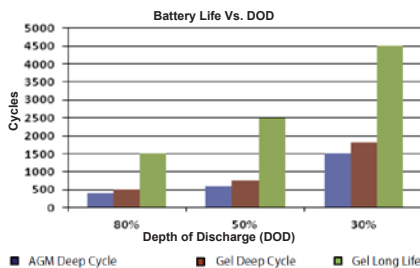
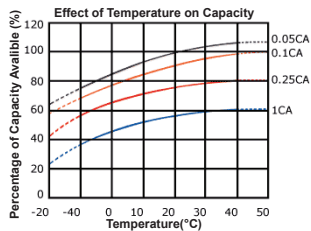

Lowest Price*
Guarantee



Worldwide*
Shipping



10 Year*
System Warranty



20 Year*
Panel Warranty



Lifetime*
Tech Support



9120 Centerlinks Commerce Drive • Unit 3 • Fort Myers • Florida • 33912 • USA • Telephone: 239-461-5522

MONDAY - FRIDAY 8:00AM - 8:00PM (US EASTERN TIME)

www.solarilluminations.com • sales@solarilluminations.com

*SUBJECT TO OUR TERMS & CONDITIONS, AND RETURNS POLICY



SL24

SOLAR DOUBLE LED STREET / PARKING LOT / AREA LIGHT
10W To 25W Double LED Lamps - Complete System With Pole

Performance

Operating voltage is 24 volts. DC.
Power consumption is typically 35, 65, 100 or 135 watts (subject to model selected).
Operating temperature -40 deg. C ~ +80 deg. C (-40 deg. F ~ 175 deg. F).
Intelligent battery management software to prevent over-charging and over-discharging.
Includes a minimum of three to five days of autonomy (battery back-up).
Several successive cloudy or overcast days typically will not affect illumination time.
Supplied solar panel power is based on installation location and system requirements.
Illumination period can be designed to meet specific requirements.



Hardware & Pole

Battery Enclosure

- Galvanized steel lockable battery enclosure will accommodate the rechargeable batteries and charge controller (padlock not included.)
- Designed to conform to NEMA 3R and IP22 rating standards for Outdoor Enclosures. Offering protection against rain, snow, and sleet. Meets the requirements of UL 508 "Rainproof enclosures".
- The battery enclosure can be mounted at the base of the pole, subject to battery selection.
- Enclosures with batteries larger than 92Ah will need to be mounted at the base of the pole.
- The enclosure has pre-drilled holes to enable secure installation to a concrete pad.
- For pole mounting, the battery enclosure includes mounting plates with slots for U-bolts or stainless steel banding.
- Silver/gray color finish. Custom colors by special order.

Arms

- Two galvanized steel arm mounts the luminaires to the light pole.
- Choice of arm length available, 6ft arm standard.
- Can be attached in any direction and any height on the pole.
- Silver/gray color finish. Custom colors by special order only.

Pole

- Galvanized steel pole with square base plate for surface mounting.
- Anchor bolts and two templates are included. The 4 pre-drilled holes on each template are approx. 3/4" (20mm) diameter.
- Pole height options are 20' or 26' (6m or 8m). 33' (10m) and other sizes are available by special order.
- The top of the pole has an outside diameter of approximately 3.7" (96mm) and tapers outwards towards the base.
- Silver/gray color finish. Custom colors by special order only.
- The location, wind factor, and ground conditions will affect the size of the foundation required.



*SUBJECT TO OUR TERMS & CONDITIONS, AND RETURNS POLICY

Lowest Price*
Guarantee



Worldwide*
Shipping



10 Year*
System Warranty



20 Year*
Panel Warranty



Lifetime*
Tech Support



9120 Centerlinks Commerce Drive • Unit 3 • Fort Myers • Florida • 33912 • USA • Telephone: 239-461-5522

MONDAY - FRIDAY 8:00AM - 8:00PM (US EASTERN TIME)

www.solarilluminations.com • sales@solarilluminations.com



SL24

SOLAR DOUBLE LED STREET / PARKING LOT / AREA LIGHT
 10W To 25W Double LED Lamps - Complete System With Pole

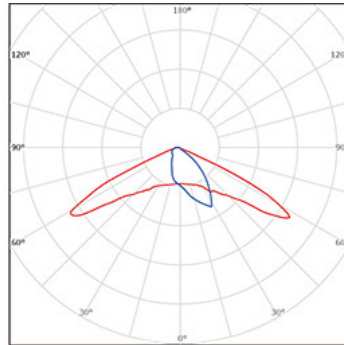
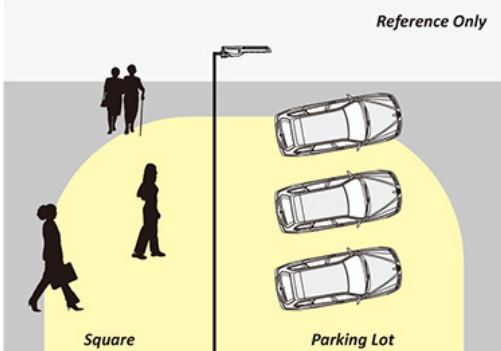
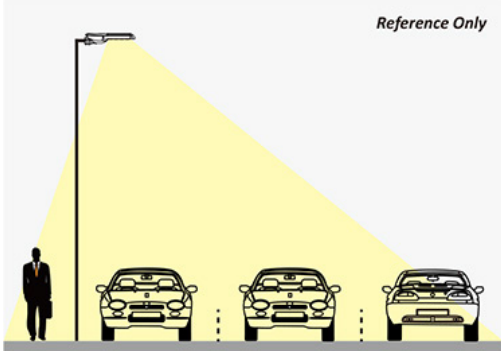
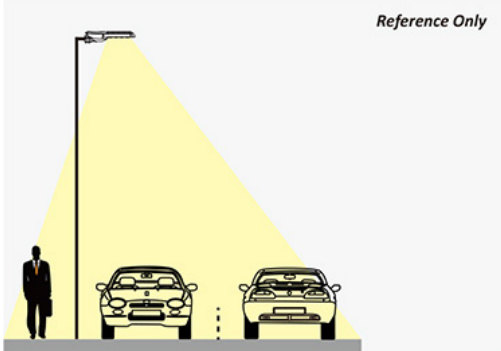
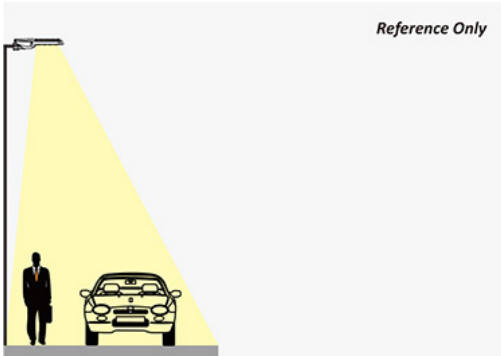

Type I

Applications:
 Narrow Roadways
 Pathways/sidewalks
 Single-track / One-Lane Roads

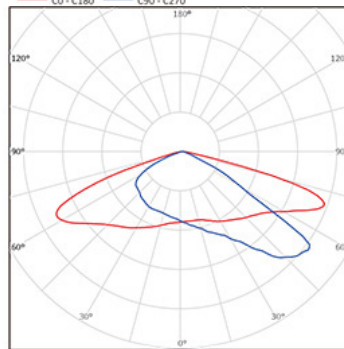
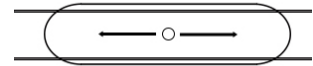

Type II

Applications:
 Urban Roadways
 Pathways/sidewalks
 Two-lane Expressway

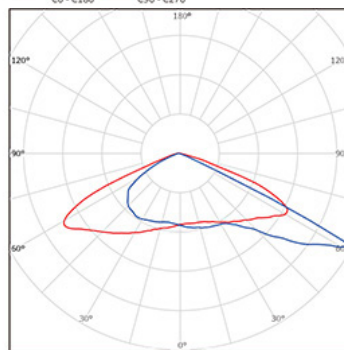
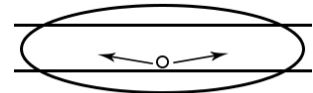

Type III

Applications:
 Highway
 Parking Lots
 Multi-lane Expressway

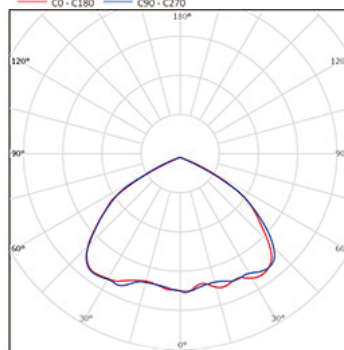
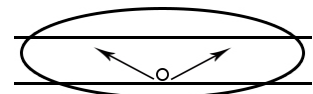

Type V

Applications:
 Parking Lots
 Area Lights

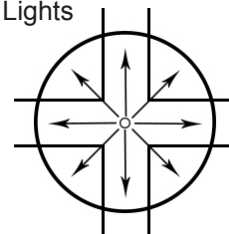

Lowest Price*
 Guarantee

Worldwide*
 Shipping

10 Year*
 System Warranty

20 Year*
 Panel Warranty

Lifetime*
 Tech Support

9120 Centerlinks Commerce Drive • Unit 3 • Fort Myers • Florida • 33912 • USA • Telephone: 239-461-5522

MONDAY - FRIDAY 8:00AM - 8:00PM (US EASTERN TIME)

www.solarilluminations.com • sales@solarilluminations.com

*SUBJECT TO OUR TERMS & CONDITIONS, AND RETURNS POLICY



SL24

SOLAR DOUBLE LED STREET / PARKING LOT / AREA LIGHT
 10W To 25W Double LED Lamps - Complete System With Pole

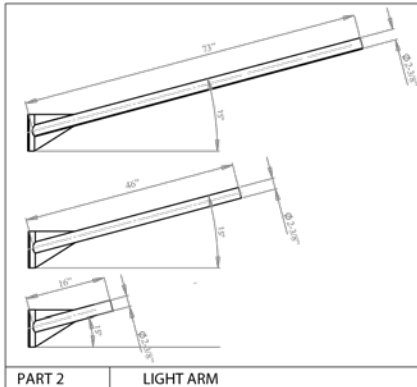

PART 2 LIGHT ARM

MATERIAL DATA	
COMPONENT	ASTM
POLE SHAFT	A595 GR.55
BASE PLATE	A36
ANCHOR BOLTS	F1554 GR.55
MISC. STEEL	A36

LOADING DATA	
DESIGN CRITERIA:	COMMERCIAL STANDARD
WIND SPEED (MPH) 1.3 GUST	80 90 100 110 120 130 140 150
EPA FT2	24.2 19.3 15.6 13.5 11.2 9.5 8.1 6.9
WEIGHT (LBS)	605 482 390 335 280 238 203 173

POLE DIMENSION DATA				
POLE LENGTH (FT)	BASE DIAMETER (IN)	TOP DIAMETER (IN)	GAUGE OR THICKNESS (IN)	WEIGHT (LBS)
20'	6 - 1/2"	3 - 3/4"	11-GA (1/8")	175

Solar illuminations poles are engineered according to AASHTO standards and accepted commercial criteria. Proper selection for an application is based on information such as EPA, wind zone, mounting height, and product attachments. This information is necessary to ensure correct engineering. Solar illuminations assumes no responsibility for proper loading analysis and/or product selections. Design information and selection guidance offered by solar illuminations customer support representatives is provided as general guidelines only. The customer remains solely responsible for proper selection of the light pole, luminaire, and/or related accessories that adhere to all applicable requirements, including (but not limited to) epa design criteria, job specifications, and engineering requirements. To ensure proper selection of the light pole, luminaire, accessories and/or foundation, solar illuminations recommends the customer consult a qualified engineer to analyze the loading and design criteria for the specific application.

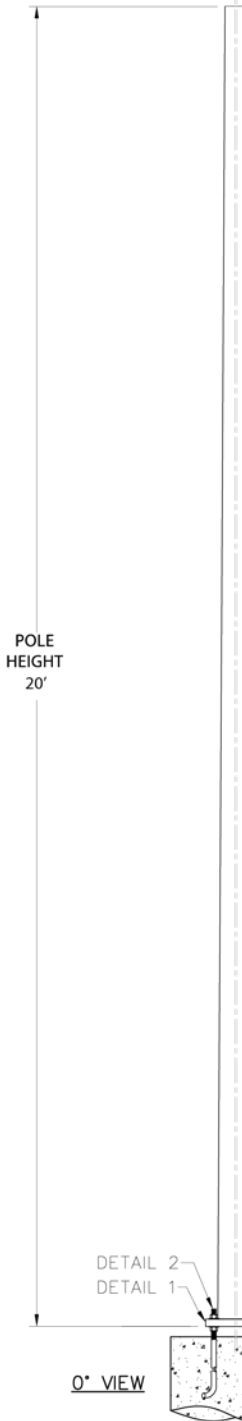

20' HD Light Pole Steel Galvanized / Painted Anchor Base

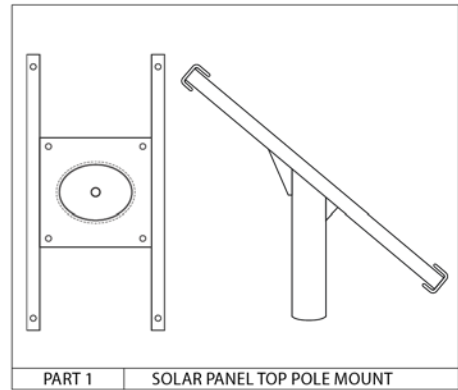

PART 1 SOLAR PANEL TOP POLE MOUNT

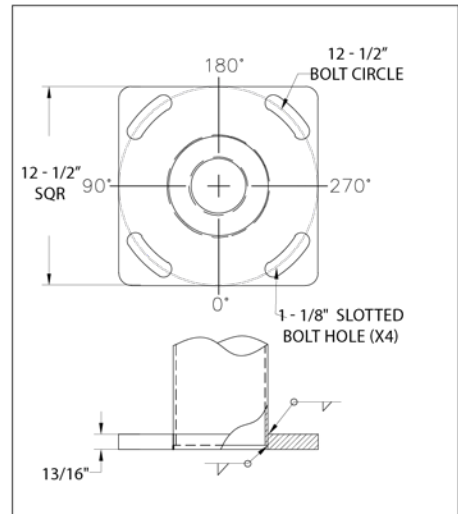

DETAIL 1 BASE PLATE

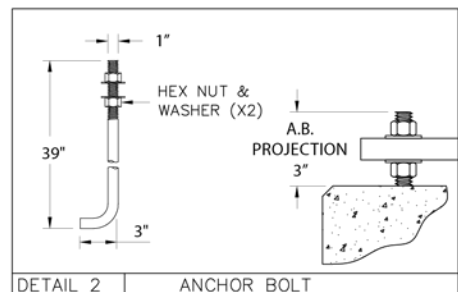

DETAIL 2 ANCHOR BOLT

Lowest Price
 Guarantee

Worldwide
 Shipping

10 Year
 System Warranty

20 Year
 Panel Warranty

Lifetime
 Tech Support

9120 Centerlinks Commerce Drive • Unit 3 • Fort Myers • Florida • 33912 • USA • Telephone: 239-461-5522

MONDAY - FRIDAY 8:00AM - 8:00PM (US EASTERN TIME)

www.solarilluminations.com • sales@solarilluminations.com

*SUBJECT TO OUR TERMS & CONDITIONS, AND RETURNS POLICY



SL24

SOLAR DOUBLE LED STREET / PARKING LOT / AREA LIGHT
 10W To 25W Double LED Lamps - Complete System With Pole

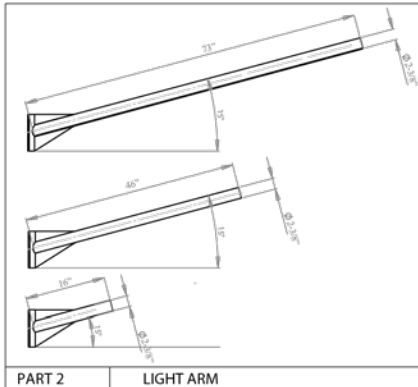

PART 2 LIGHT ARM

MATERIAL DATA	
COMPONENT	ASTM
POLE SHAFT	A595 GR.55
BASE PLATE	A36
ANCHOR BOLTS	F1554 GR.55
MISC. STEEL	A36

LOADING DATA	
DESIGN CRITERIA:	COMMERCIAL STANDARD
WIND SPEED (MPH) 1.3 GUST	80 90 100 110 120 130 140 150
EPA FT2	24.2 19.3 15.6 13.5 11.2 9.5 8.1 6.9
WEIGHT (LBS)	605 482 390 335 280 238 203 173

POLE DIMENSION DATA				
POLE LENGTH (FT)	BASE DIAMETER (IN)	TOP DIAMETER (IN)	GAUGE OR THICKNESS (IN)	WEIGHT (LBS)
26'	7"	3 - 3/4"	11-GA (1/8")	200

Solar illuminations poles are engineered according to AASHTO standards and accepted commercial criteria. Proper selection for an application is based on information such as EPA, wind zone, mounting height, and product attachments. This information is necessary to ensure correct engineering. Solar illuminations assumes no responsibility for proper loading analysis and/or product selections. Design information and selection guidance offered by solar illuminations customer support representatives is provided as general guidelines only. The customer remains solely responsible for proper selection of the light pole, luminaire, and/or related accessories that adhere to all applicable requirements, including (but not limited to) epa design criteria, job specifications, and engineering requirements. To ensure proper selection of the light pole, luminaire, accessories and/or foundation, solar illuminations recommends the customer consult a qualified engineer to analyze the loading and design criteria for the specific application.

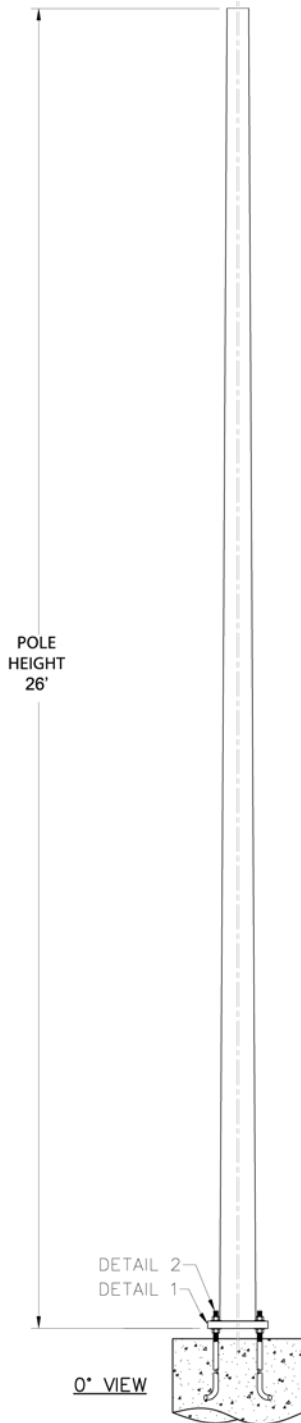

26' HD Light Pole Steel Galvanized / Painted Anchor Base

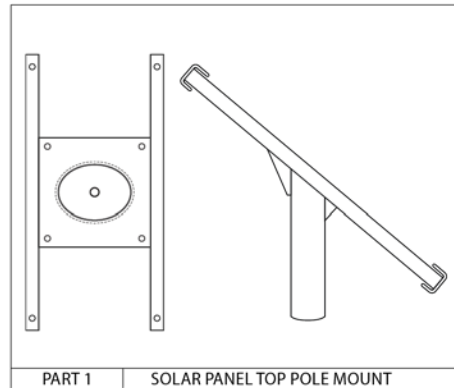

PART 1 SOLAR PANEL TOP POLE MOUNT

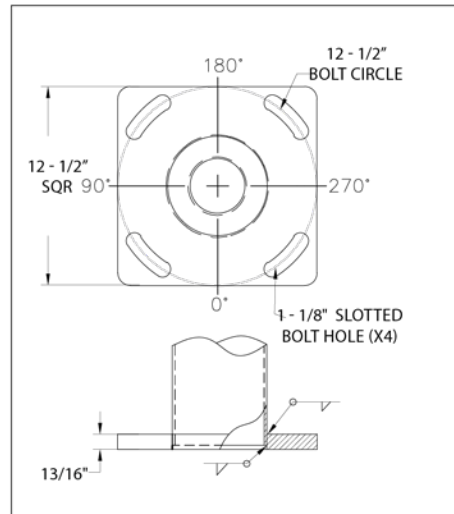

DETAIL 1 BASE PLATE

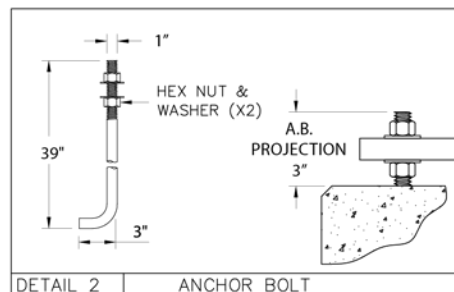

DETAIL 2 ANCHOR BOLT

*SUBJECT TO OUR TERMS & CONDITIONS, AND RETURNS POLICY

Lowest Price
 Guarantee

Worldwide
 Shipping

10 Year
 System Warranty

20 Year
 Panel Warranty

Lifetime
 Tech Support

9120 Centerlinks Commerce Drive • Unit 3 • Fort Myers • Florida • 33912 • USA • Telephone: 239-461-5522

MONDAY - FRIDAY 8:00AM - 8:00PM (US EASTERN TIME)

www.solarilluminations.com • sales@solarilluminations.com



SL24

SOLAR DOUBLE LED STREET / PARKING LOT / AREA LIGHT
10W To 25W Double LED Lamps - Complete System With Pole



Lowest Price*  **Guarantee** **Worldwide***  **Shipping** **10 Year***  **System Warranty** **20 Year***  **Panel Warranty** **Lifetime***  **Tech Support**

9120 Centerlinks Commerce Drive • Unit 3 • Fort Myers • Florida • 33912 • USA • Telephone: 239-461-5522

MONDAY - FRIDAY 8:00AM - 8:00PM (US EASTERN TIME)

www.solarilluminations.com • sales@solarilluminations.com

*SUBJECT TO OUR TERMS & CONDITIONS, AND RETURNS POLICY